

↗ DOMETIC

REFRIGERATION

8 SERIES



RMD8501, RMD8505, RMD8551,
RMD8555

EN

Absorber refrigerator
Operating manual



For your safety



DANGER !



Never use an unshielded flame to check gas bearing parts and pipes for leakage! There is a danger of fire or explosion.



WARNING!

The refrigerator is not suitable for the proper storage of medication. Please observe in addition the instructions in the medication package inserts.

Never open the absorber cooling unit! It is under high pressure.
There is a danger of injury!

Work on gas equipment, exhaust system and electrical facilities must be carried out by authorised personnel only. Substantial damage to property and/or injury to persons can arise through unprofessional procedures.

Protect children:

When disposing of the refrigerator, detach all refrigerator doors and leave the storage racks in the refrigerator. In this way inadvertent entrapment and suffocation is prevented.

Operating the appliance with gas is not permitted

- at petrol stations
- on ferry boats
- while transporting the caravan/motorhome by a transporter or breakdown vehicle.

**There is the danger of fire!
Switch off the appliance.**

As a basic rule, gas operation is prohibited in petrol stations!

Making ice cubes:

Only use drinking water!

**WARNING!**

It is imperative that the operating pressure of the pressure reducer on the gas system corresponds to the data specified on the rating plate of the refrigerator. If the values are different, the appliance can be damaged and a dangerous situation can be produced.

**CAUTION!**

The refrigerator unit becomes very hot during operation. Protect yourself against contact with high temperature parts when ventilation grilles are removed.

If the connection cable is damaged it must be replaced by the Customer Service at Dometic, or by respectively qualified personnel, in order to prevent any hazards.

As a basic rule, shut and lock the refrigerator before you start your journey!

CAUTION!**Changing the batteries :**

- Remove discharged batteries.
- Replace the batteries completely.
- Do not mix different types of batteries.
- Observe the correct polarity !
- Do not connect non-rechargeable batteries to a charger.
- Remove rechargeable batteries from the battery compartment before charging.
- Avoid short circuits on the contacts in the battery compartment!
- Remove the batteries from the battery compartment if the refrigerator will not be used for a long time.

Operation with 230V~ :

This option should only be selected where the supply voltage of the connection for power supply corresponds to the value specified on the data plate. Any difference in values may result in damage the appliance.

Defrosting:

The layer of ice must never be removed forcibly, nor may defrosting be accelerated using a heat source!

Table of contents

1.0	General	6
1.1	Introduction	6
1.2	Guide to these operating instructions	6
1.3	Copyright protection	6
1.4	Explanation of symbols used in this manual	6
1.5	Warranty	7
1.6	Limitation of liability	7
1.7	Customer services	7
1.8	Spare parts	7
1.9	Environmental notices	8
1.9.1	Disposal	8
1.9.2	Energy-saving-tips	8
2.0	Safety instructions	9
2.1	Application according to regulations	9
2.2	User's responsibility	9
2.3	Protection of children when disposing of the equipment	9
2.4	Working upon and checking the refrigerator	9
2.5	Information on coolant	10
2.6	Operating the refrigerator with gas	10
2.7	Safety instructions when storing foodstuffs	11
3.0	Description of model	12
3.1	Model identification	12
3.2	Refrigerator rating plate	12
3.3	Technical data	13
3.4	Description of refrigerator	13
4.0	Refrigerator operation	14
4.1	Cleaning	14
4.2	Maintenance	14
4.3	Electrical operation	14
4.4	Gas operation (Liquid gas)	15
4.5	Explanation of operating controls	15
4.6	RMD 8xx1models	17
4.6.1	Electrical operation	17
4.6.2	Gas operation	17
4.6.3	Setting of cooling compartment temperature	17
4.7	RMD 8xx5 models	17
4.7.1	Manual operation	17
4.7.2	Automatic operation	18
4.7.3	Setting of cooling compartment temperature	18
4.7.4	Refuelling while in automatic mode operation	18
4.7.5	Additional features	18
4.8	Gas operation with internal batteries (optional)	19
4.8.1	Inserting / changing the batteries	19
4.9	Frameheating	20
4.10	Door locking	20
4.10.1	Fastening and releasing the door lock hook when parking the vehicle	21

4.11	Lighting	21
4.12	Positioning the storage racks	21
4.13	Storing food and making ice cubes	22
4.13.1	Storing products in the cooling compartment	22
4.13.2	Storing products in the freezer compartment	22
4.13.3	Refrigerator compartments	22
4.13.4	Making ice cubes	23
4.14	Shutting off the refrigerator	23
4.15	Defrosting	23
4.16	Changing the decor panel	24
4.17	Troubleshooting	25
4.18	Information on failure display and trouble-shooting	26
4.18.1	Status indicators	26

Dometic GmbH
In der Steinwiese 16
D-57074 Siegen
www.dometic.com

© Dometic GmbH - 2014 - Subject to change without prior notice

1.0 General

1.1 Introduction

You have made an excellent choice in selecting the **Dometic** Absorption Refrigerator. We are sure that you will be satisfied with your new refrigerator in all respects. The refrigerator, which works silently, meets high quality standards and guarantees the efficient utilisation of resources and energy throughout its entire life cycle, during manufacture, in use and when being disposed of.

1.2 Guide to these operating instructions

Before you start using the refrigerator, please read the operating instructions carefully.

These instructions provide you with the necessary guidance for the proper use of your refrigerator. **Observe in particular the safety instructions.** Observation of the instructions and handling recommendations is important for dealing with the refrigerator safely and for protecting you from injury and the refrigerator from damage. You must understand what you have read before you carry out a task.

Keep these instructions in a safe place close to the refrigerator so they may be referred to at any time.

1.3 Copyright protection

The information, texts and illustrations in these instructions are copyright protected and are subject to industrial property rights. No part of these instructions may be reproduced, copied or utilised in any other way without written authorisation by Dometic.

1.4 Explanation of symbols used in this manual

Warning notices

Warning notices are identified by symbols. A supplementary text gives you an explanation of the degree of danger.

Observe these warning notices rigorously. You will thus protect yourself and other people from injury, and the appliance from damage.



DANGER!

DANGER indicates an imminent hazardous situation which, if not avoided, could result in death or serious injury.



WARNING!

WARNING indicates a potentially hazardous situation which, if not avoided, could result in death or serious injury



CAUTION!

WARNING indicates a potentially hazardous situation which, if not avoided, could result in death or serious injury

CAUTION!

CAUTION (used without the safety alert symbol) indicates a potentially hazardous situation which, if not avoided, may result in damage to the appliance.

Information



INFORMATION gives you supplementary and useful guidance when dealing with your refrigerator.

Environmental Tips



ENVIRONMENTAL TIPS gives you useful guidance for saving energy and disposal of the appliance.

1.5 Warranty

Warranty arrangements are in accordance with the normal conditions applicable for the country concerned. For warranty or other maintenance, please contact our customer services department. Any damage due to improper use is not covered by the warranty. The warranty does not cover any modifications to the appliance or the use of **non-original Dometic** parts. The warranty does not apply if the installation and operating instructions are not adhered to and no liability shall be entertained.

1.6 Limitation of liability

All information and guidance in these operating instructions were prepared after taking into consideration the applicable standards and regulations as well as the current state of the art. **Dometic** reserves the right to make changes at any time which are deemed to be in the interest of improving the product and safety.

Dometic will assume no liability for damage in the case of :

- non-observation of the operating instructions
- application not in accordance with the regulations or provisions
- use of non-original spare parts
- modifications and interferences to the appliance

1.7 Customer services

Dometic offers a customer service network. . You can obtain the address information of the nearest customer service from **www.dometic.com**. When contacting Dometic Customer Services, please state the model, product number and serial number together with the MLC code, if applicable. You will find this information on the rating plate inside the refrigerator. We recommend that you note this data in the field provided on the front page of this operation manual.

1.8 Spare parts

Parts can be ordered throughout Australia and New Zealand from our service dealer network.

Always give the model and product number when you contact the customer service! You will find this information on the rating plate inside the refrigerator.

1.9 Environmental notices



Refrigerators manufactured by Dometic are free of CFC/HCFC and HFC. Ammonia (a natural compound of hydrogen and nitrogen) is used in the cooling unit as a coolant. Non-ozone-hazardous cyclopentane is used as a propellant for manufacturing PU foam insulation.

1.9.1 Disposal

In order to ensure that the recyclable packaging materials are re-used, they should be sent to the customary local collection system. The appliance should be transferred to a suitable waste disposal company that will ensure re-use of the recyclable components and proper disposal of the rest. For eco-friendly draining of the coolant from all absorber refrigeration units, a suitable disposal plant should be used.



Do not dispose of batteries in domestic waste. Take your used batteries to your dealer or a collection point.

1.9.2 Energy-saving-tips

- At an average ambient temperature of 25°C, it is sufficient to operate the refrigerator at middle thermostat setting.
- Where possible, always store precooled products.
- Do not expose the refrigerator to direct sunlight or any other heat source (e.g. heater).
- Ensure that air circulation of the refrigeration unit is not obstructed.
- Arrange the shelves evenly in the refrigerator (in the cooling compartment) in order to achieve the most efficient use of energy.

- Do not overfill the storage grids and compartments to prevent obstructing the internal air circulation.
- Maintain a clearance of approx. 10 mm between chilled products and post-evaporator ("cooling fins").
- Defrosting at regular intervals saves energy (see section "Defrosting").
- Open the refrigerator door only for a short period of time when removing products.
- Run the refrigerator for about 12 hours before filling it.

2.0 Safety instructions

2.1 Application according to regulations

This refrigerator is designed for installation in recreation vehicles such as caravans or motorhomes.

The refrigerator is to be used solely for storing foodstuffs.



WARNING!

The refrigerator is not suitable for the proper storage of medication. Please observe in addition the instructions in the medication package inserts.

2.2 User's responsibility

Anyone operating the refrigerator must be familiar with the safe handling and understand the advice in these operating instructions.

This appliance is not intended for use by persons (including children) with reduced physical, sensory or mental capabilities, or lack of experience and knowledge, unless they are supervised or have been given instruction concerning use of the appliance by a person responsible for their safety. Children should be supervised to ensure that they do not play with the appliance. Cleaning and user maintenance shall not be made by children.

2.3 Protection of children when disposing of the equipment



WARNING!

When disposing of the refrigerator, detach all refrigerator doors and leave the storage racks in the refrigerator. In this way inadvertent entrapment and suffocation is prevented.

2.4 Working upon and checking the refrigerator



WARNING!

Work on gas equipment, exhaust system and electrical facilities must be carried out by authorised personnel only. Substantial damage to property and/or injury to persons can arise through unprofessional procedures.



DANGER!



Never use an unshielded flame to check gas bearing parts and pipes for leakage!

There is a danger of fire or explosion.



WARNING!

Never open the absorber cooling unit! It is under high pressure.

There is a danger of injury!

2.5 Information on coolant

Ammonia is used as a coolant.

This is a natural compound also used in household cleaning agents (1 litre of Salmiak cleaner contains up to 200g of ammonia - about twice as much as is used in the refrigerator). Sodium chromate is used for corrosion protection (1.8% by weight of the solvent).

In the event of leakage (easily identifiable from the strong odour), proceed as follows:

- Switch off the appliance.
- Air the room thoroughly.
- Inform authorised customer services.



For your safety it was ascertained in an expert's report that no impairment of health exists when the coolant is discharged.

2.6 Operating the refrigerator with gas

It is imperative that the operating pressure of the pressure reducer on the gas system corresponds to the data specified on the rating plate of the refrigerator. Compare the operating pressure of the rating plate with the data specified on the pressure reducing valve of the liquid gas cylinder.



WARNING!

Operating the appliance with gas is not permitted

- at petrol stations
- on ferry boats
- while transporting the caravan/motor-home by a transporter or breakdown vehicle.

Leave the equipment switched off.

If you smell gas:

- Open all windows and leave the room.
- Do not operate any electrical equipment and prevent the use of naked flames.
- If it is safe to do so, turn the gas supply off.
- Contact authorised specialist personnel* for advice.

*** authorised specialist personnel**

Authorised specialist personnel are accredited experts who are able, by virtue of their training and knowledge, to vouch that the inspection and repair work has been carried out properly.

2.7 Safety instructions when storing foodstuffs

No refrigerator of any kind can improve the quality of the food; refrigerators can only maintain the food's quality for a short duration as from the time of storing it.

Please observe the following particular conditions for storing food in a refrigerator that is built into a vehicle:

- A change in the climatic conditions such as temperature fluctuations
- High temperatures inside the vehicle when it is closed and parked in direct sunlight (temperatures are possible up to 50°C)
- A refrigerator built in behind a window and exposed to direct sunlight
- Storing the products too soon, i.e. shortly after starting up the appliance for use
- Use of the refrigerator during travel with the power supply of 12V DC
- Fluctuations in the power supply at the parking place when using the energy type 230V~ (mains voltage).

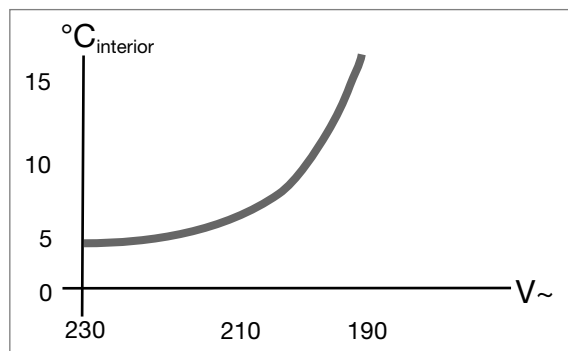

schematic

Under these particular conditions the refrigerator cannot guarantee reaching the temperature needed for perishables.

Perishables include all products with a stipulated use-by date and a minimum storage temperature of +4°C or less, especially for meat, poultry, fish, sausages, pre-packed foods.

- Pack raw and cooked foods separately (e.g. in containers, aluminium foil, etc.).
- Only remove the outside packaging of single packs if all the necessary information, e.g. the use-by date, can also be read on the single packs.
- Please observe the instructions and information regarding the use-by date on the outside packaging of the food.
- Do not leave cooled goods outside the refrigerator for too long.
- Place the foods with the next use-by date at the front, accordingly.
- Pack away any left-over food and eat at the first opportunity.
- Wash your hands before and after handling any food.
- Regularly clean the inside of the refrigerator.
Please observe section 4.1 *Cleaning* of this instruction.



The cooling unit's performance is influenced by ambient temperatures. Please select the medium setting for ambient temperatures between +15°C and +25°C (refer to *Setting of cooling compartment temperature*). The unit operates within its optimum performance range.

Dometic refrigerators work according to the absorption principle. For physical reasons, an absorption system responds slowly to changes made by the thermostat controller, by loss of cooling energy through opening the door or during storing food.

3.0 Description of model

3.1 Model identification

Example :

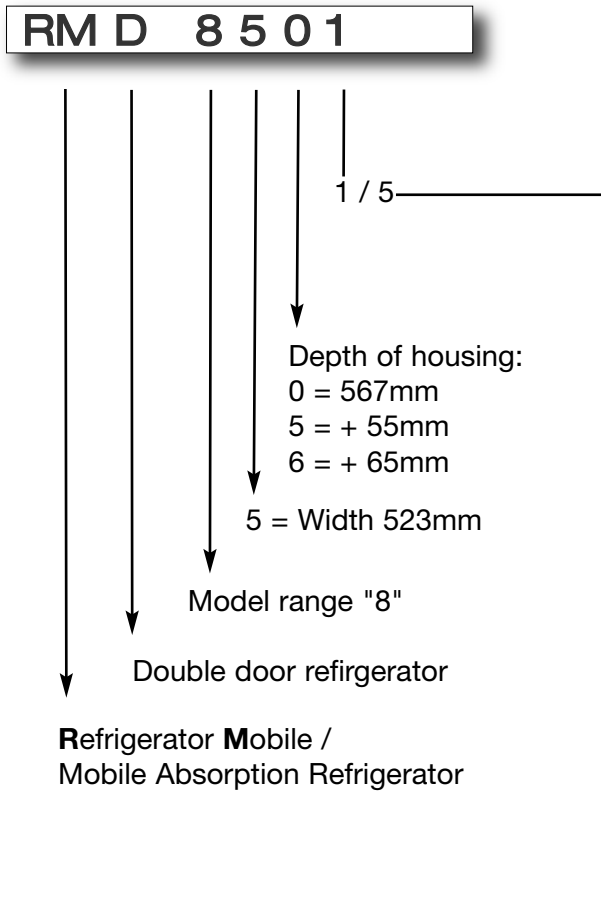

- 1
 manual energy selection, automatic ignition
(MES)
- 5
 automatic and manual energy selection,
 automatic ignition **(AES)**

3.2 Refrigerator rating plate

The rating plate is to be found on the inside of the refrigerator. It contains all important details of the refrigerator. You can read off from this the model identification, the product number and the serial number. You will need these details whenever you contact the customer service centre or when ordering spare parts.

Example of rating plate

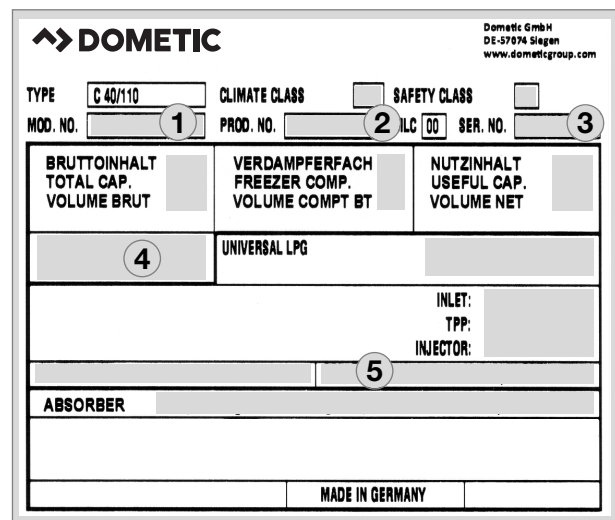

Example

Fig. 1

- 1** Model number
- 2** Product number
- 3** Serial number
- 4** Electrical rating details
- 5** Gas pressure

3.3 Technical data

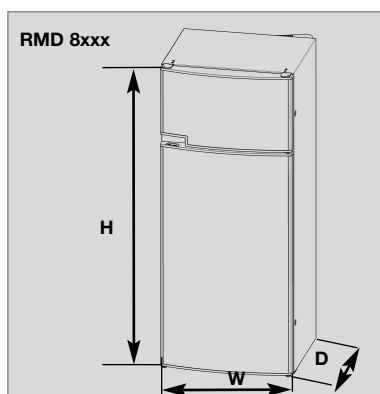

Fig. 2

Subject to technical changes.

*Average consumption measured at an average ambient temperature of 25°C in pursuance of ISO Standard.

Model	Dimensions H x W x D (mm) Depth incl. door	Gross capacity with freezer		Rating details mains/battery over 24hrs	Consumption * electricity/gas	Net weight	Ignition	
		compartment	freezer				Piezo	Automat
RMD 8501	1245x523x567	160 lit.	30 lit.	250 W / 170 W	ca. 3.9 kWh / 460 g	40 kg		•
RMD 8505	1245x523x567	160 lit.	30 lit.	250 W / 170 W	ca. 3.9 kWh / 460 g	40 kg		•
RMD 8551	1245x523x622	190 lit.	35 lit.	250 W / 170 W	ca. 3.9 kWh / 460 g	41.5 kg		•
RMD 8555	1245x523x622	190 lit.	35 lit.	250 W / 170 W	ca. 3.9 kWh / 460 g	41.5 kg		•

3.4 Description of refrigerator

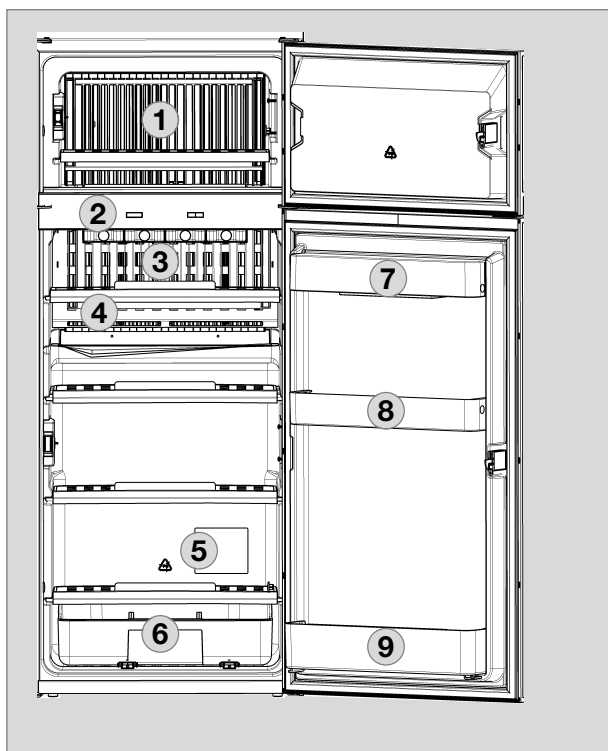

Fig. 3

- ① Freezer compartment
- ② Operating controls
- ③ Post-evaporator for cooling compartment
- ④ Condensation water drain channel
- ⑤ Data plate
- ⑥ Vegetable bin
- ⑦ Upper door shelf with flap, egg shelf available as option may be inserted
- ⑧ Middle door shelf
- ⑨ Lower door shelf with bottle holders

4.0 Refrigerator operation

The refrigerator is equipped to operate on three power modes:

- **Mains voltage (230V AC)**
- **Direct-current voltage (12V DC)**
- **Gas (Universal LP Gas)**

Select the desired power mode by the **energy selector switch** (battery igniter type models) or the **energy selector button** (MES, AES). Appliances with automatic energy selection (**AES**) are additionally provided with "automatic mode" function. Then the AES system automatically selects the best energy source for each particular situation.



- When the appliance is first put into operation, there may be a mild odour which will disappear after a few hours.
- Park the vehicle level, particularly when starting up the refrigerator and filling with food before starting a journey.
- The cooling unit is silent in operation.
- The refrigerator will take several hours to reach its operating temperature in the cooling compartment. The freezer compartment should be cold about one hour after switching on the refrigerator.

4.1 Cleaning

Before starting up the refrigerator, it is recommended that you clean it inside and repeat this at regular intervals.

Use a soft cloth and lukewarm water with a mild detergent. Then wipe out the appliance with clean water and dry thoroughly.

Keep the condensation water drain channel free of deposits.

To avoid material alterations, do not use soap or hard, abrasive or soda-based cleaning agents. Do not allow the door seal to come into contact with oil or grease.

4.2 Maintenance

- **The gas burner must be inspected and cleaned as necessary at least once a year.** Keep the evidence of maintenance work carried out on your refrigerator.

- **Work on gas and electrical equipment shall be carried out by qualified personnel only.**

It is recommended that this is carried out by an authorised customer services department.

We recommend maintenance following an extended shutdown of the vehicle. Please contact our customer services.

4.3 Electrical operation

12V-voltage (on-board power supply)

CAUTION!

The refrigerator should only be used in 12VDC-operation while the vehicle's engine is running, otherwise the on-board-battery would be discharged within a few hours!

Mains power (230V)

CAUTION!

This option should only be selected where the supply voltage of the connection for power supply corresponds to the value specified on the data plate. Any difference in values may result in damage the appliance.

4.4 Gas operation (Universal LP Gas)

- The refrigerator must be operated using Universal LP Gas (no natural gas or town gas).
- For physical reasons, gas ignition faults could occur starting from an altitude above sea level of approx. 3280 ft. / 1000 m (**No malfunction!**)
- On the initial refrigerator start-up or after a cylinder change, air may be trapped in the gas line. To purge the air from the lines, switch on the refrigerator and any other gas appliances (e.g. stove) for a short time.

 **WARNING!**
Gas operation is prohibited in petrol stations!

Prior to starting the refrigerator in gas mode :

- Open the gas cylinder valve.
- Open the shut-off valve for gas supply to the refrigerator.

NOTE!

Proceed to the description that applies to **YOUR** model.

4.5 Explanation of operating controls

The control panel buttons are not accessible when the refrigerator door is closed. Open the bottom door to reach the operating buttons.

Depending on the door opening direction, there are two LEDs on the left or right edge of the control panel. The outer LED (**1**) indicates that the refrigerator is operational (blue). The other LED (**2**) lights red in the event of a fault.

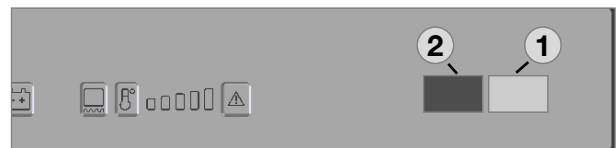

Indicator LEDs

Fig. 4

Refrigerators for **self-contained (gas) operation** contain two battery compartments in the control panel which are located on the left and right next to the button bar.



Operating controls without battery compartments

Fig. 5



Operating controls with battery compartments (L, R)

Fig. 6

Manual energy selection / automatic ignition (RMD 8xx1) MES :

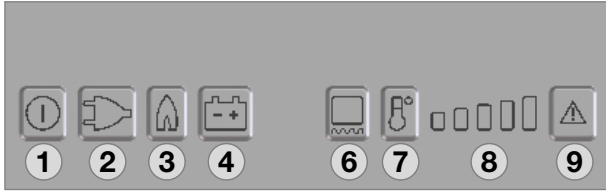

Fig. 7

- ① = Power **ON/OFF** switch
- ② = Energy selector button 230V AC
- ③ = Energy selector button GAS
- ④ = Energy selector button 12V DC
- ⑥ = Pushbutton ON/OFF frameheating
- ⑦ = Temperature level selection
- ⑧ = Temperature level display
- ⑨ = Indicator LED failure /
Reset button GAS FAILURE

Switching ON/OFF

- Switch ON by pressing button (1), 2s
- Switch OFF by pressing button (1), > 2s

240V AC operation

- Select "Mains voltage" by pressing button (2)
- Set temperature step by pressing button (7)

12V DC operation (vehicle's battery)

- Select "Battery voltage" by pressing button (4)
- Set temperature step by pressing button (7)

Gas operation

- Select "Gas" by pressing button (3)
- Set temperature step by pressing button (7)

Automatic energy selection / automatic ignition (RMD 8xx5) AES :



Fig. 8

- ① = Power **ON/OFF** switch
- ② = Energy selector button 230V AC
- ③ = Energy selector button GAS
- ④ = Energy selector button 12V DC
- ⑤ = Selector button "AUTOMATIC"
- ⑥ = Pushbutton ON/OFF frameheating
- ⑦ = Temperature level selection
- ⑧ = Temperature level display
- ⑨ = Indicator LED failure /
Reset button GAS FAILURE

Switching ON/OFF

- Switch ON by pressing button (1), 2s
- Switch OFF by pressing button (1), > 2s

Manual operation

- Select energy source with buttons (2,3,4)
- Set temperature step by pressing button (7)

Automatic operation

- Change over to "Automatic" with button (5)
Automatical energy selection (if available)
Sequence of priority:
 - 1.) Solar (12V DC)
 - 2.) 230V AC
 - 3.) 12V DC
 - 4.) Liquid gas
- Set temperature step by pressing button (7)

4.6 RMD 85x1 models

MES-appliances (manual energy selection)

4.6.1 Electrical operation

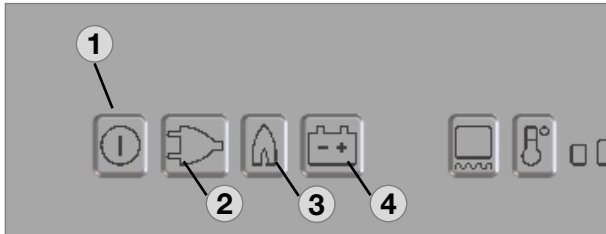

Fig. 9

To start the refrigerator, press button **(1)** for **2 seconds**.

The refrigerator starts with the last selected type of energy.

240V operation :

Press button **(2)** :



12V operation :

Press button **(4)** :



4.6.2 Gas operation

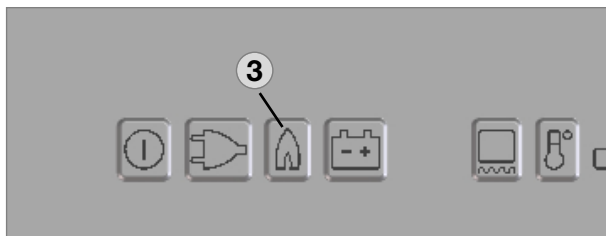

Fig. 10

Gas operation :

Press button **(3)** :



The ignition process is activated automatically by means of an automatic igniter.



The flame extinguishes after reaching the pre-set cooling compartment temperature and ignites again if the cooling compartment temperature increases again. If the flame is not lit after the first ignition attempt, the automatic igniter repeats the ignition twice (duration 30 s) at time intervals of 2 minutes. If the flame is not lit afterwards, a fault is indicated.

4.6.3 Setting of cooling compartment temperature

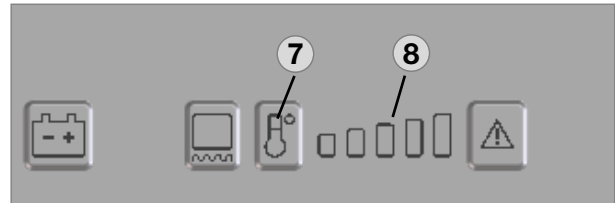

Fig. 11

Select the desired cooling compartment temperature by pressing button **(7)** .

The LED display **(8)** of the selected temperature setting is illuminated.

The scale starts with **MIN position** at the left LED position (small bar = highest temperature) and climbs up to **MAX position** at the right LED position (large bar = lowest temperature). Note: The temperature levels do not relate to absolute temperature values.

4.7 RMD 85x5 models

AES appliances

(manual + automatic energy selection)

4.7.1 Manual operation

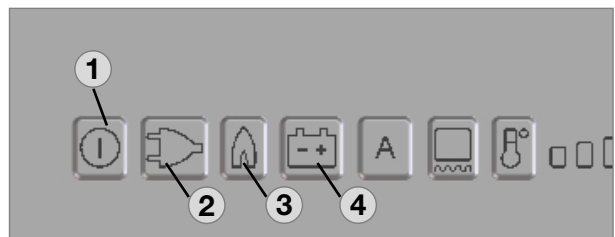

Fig. 12

To start the refrigerator, press button **(1)** for **2 seconds**.

The refrigerator starts with the last selected type of energy.

240V operation :

Press button **(2)** :



12V operation :

Press button **(4)** :



Gas operation :

Press button **(3)** :



4.7.2 Automatic operation

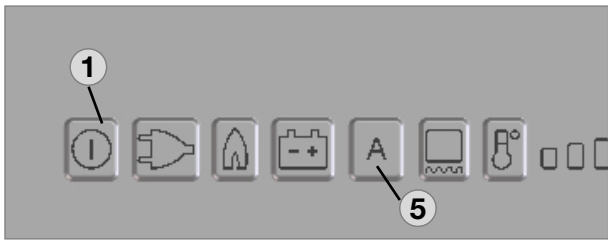

Fig. 13

To start the refrigerator, press button **(1)** for **2 seconds**.

The refrigerator starts with the last selected type of energy.

Automatic operation :

Press button**(5)** : **A**

Upon switching on, the electronics **automatically** selects one of the three possible energy types: **240V - 12V - LP Gas**. The control electronics automatically ensures that the refrigerator is supplied with the optimum source of energy in each respective case.

Sequence of priority:

- 1.) **Solar (12V DC)**
- 2.) **240V AC**
- 3.) **12V DC**
- 4.) **LP Gas**



If sufficient mains voltage is available (more than 195 V), this power source is selected as prime option. If a solar system capable of powering the refrigerator is installed, the solar 12V supply takes priority.

The 12V operation is otherwise only effective while the engine is running.

According to the sequence of priority the electronics selects **GAS** as energy source only, if both of the electrical energy source are not available.

Manual operation is possible at any time.

4.7.3 Setting of cooling compartment temperature

see point 4.6.3 *Setting of cooling compartment temperature* .

4.7.4 Refuelling while in AES mode operation



In order to prevent unintended switching to gas operation during refuelling, the electronic system starts gas operation of the refrigerator after the motor has been turned off for 15 minutes. During this period the appliance is ready for operation ("stand-by"). The temperature level LEDs do not light then while all other indicators remain active.



WARNING!

The use of naked flames is prohibited in petrol station environments.

Should the refuelling stop last longer than 15 minutes, the refrigerator has to be switched off or switched over to another energy type.

4.7.5 Additional features (MES / AES)

- The brightness of the display reduces after a few seconds if no other buttons are pressed. The indicator lights again if a button is pressed. Press the button again to activate the required function.
- Failures are indicated by flashing of the failure indicator LED.
- Should the door be kept open for too long (more than 2 minutes), an acoustic signal is initiated (pulsing whistle tone).
- Should the electronic control detect any failure, an acoustic signal will sound (pulsing whistle tone). At the same time the display starts flashing (please refer to section *Information on failure display and troubleshooting*).

4.8 Self-contained gas operation and optional battery compartment

An optional battery compartment in the electronics case for internal (self-contained) power supply of the electronics is available for the model variants RMD 8xx1 (appliances with electronics).

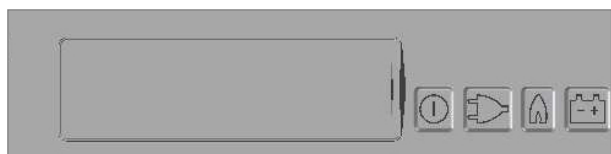

Left battery compartment

Fig. 14



Batteries are not included !

Load the battery compartment with batteries (**8 x AA 1.5 V**) before operating the refrigerator.

Self-contained gas operation

All operating modes can be selected while the on-board 12 V DC power supply is active. The battery compartment is disconnected from the power supply.

If the vehicle on-board 12 V DC power supply is not present or there is an interruption of the mains power supply during operation, the electronics automatically switch to the appliance internal battery power supply.

The refrigerator can now only be operated in the gas mode.

All LED indicators except the **GAS LED** are not lit during operation with the batteries inside the appliance. The **GAS LED** flashes every **15 seconds**.

If a button is pressed, the temperature level LEDs (7, Fig. 7/ 8) also light.

If the voltage of the battery inside the appliance is too low, an acoustic signal (whistle tone) sounds every 15 seconds.

Then replace the batteries in the battery compartment

4.8.1 Inserting / changing the batteries

Switch off the refrigerator, as described in section *Shutting of the refrigerator*.

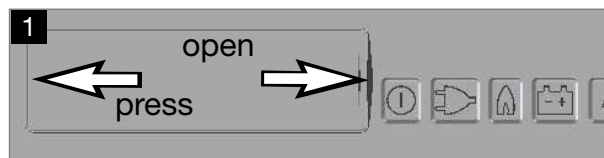

Opening left battery compartment

Fig. 15

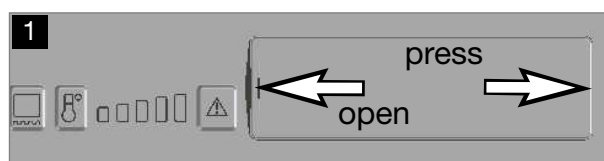

Opening right battery compartment

Fig. 16

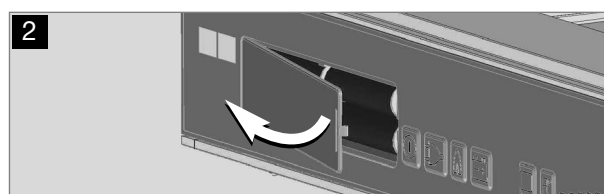

Fig. 17

CAUTION!

- Remove discharged batteries.
- Replace the batteries completely.
- Do not mix different types of batteries.
- Observe the correct polarity !
- Do not connect non-rechargeable batteries to a charger.
- Remove rechargeable batteries from the battery compartment before charging.
- Avoid short circuits on the contacts in the battery compartment!
- Remove the batteries from the battery compartment if the refrigerator will not be used for a long time.



Protect the environment!

Do not dispose of batteries in domestic waste. Take your used batteries to your dealer or acollection point.

4.9 Frame heating

All models are equipped with a frame heating (12VDC/3,5W) around the freezer compartment. During summer months with high temperatures and humidity the metal frame may have water droplets forming. To evaporate these droplets switch on the frame heating with button **(6)** .

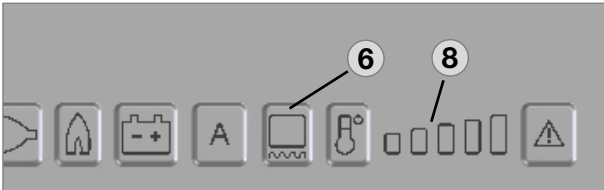

Fig. 18

Operation with gas mode or 12V mode :

The operating time of the frame heater can be set to 2 hours, 5 hours or continuous operation. After selecting the operating time using the button **(6)**, the temperature level indicator **(8)** is extinguished for a short time to show the set operating time for a few seconds. The display then returns to the temperature level indicator.

Operating time : 2 h

Press button **(6)** once



Display

Operating time : 5 h

Press button **(6)** twice



Display

Permanent operation

Press button **(6)** three times



Display



Operation with 230 V mode and 12 V mode AES (automatic operation) :

The frame heater is switched on continuously. There is no indication on the control panel.

Gas mode :

CAUTION!

In order to prevent discharge of the on-board battery, change the frame heater from continuous operation to another operating time or switch it off.

4.10 Door locking



CAUTION!

As a basic rule, shut and lock the refrigerator before you start your journey!

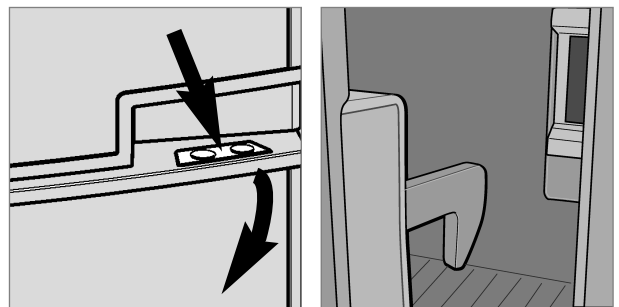

Fig. 19

Fig. 20

Open the door by pressing the locking button and pull open (see Fig. 19).

Shut the door again by pushing it to close. The snapping into the lock can be heard.

While the vehicle is parked, the locking hook may be fixed to facilitate opening of the door (Fig 21-22).

4.10.1 Fastening and releasing the doorlock hook when parking the vehicle

If the vehicle is parked for a longer period of time, the locking hook may be clamped by means of a lockbar. The door may now be opened by just pulling it without need of pressing the locking button.

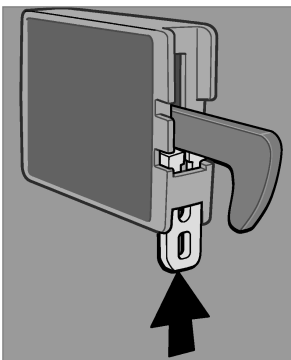

Fastening

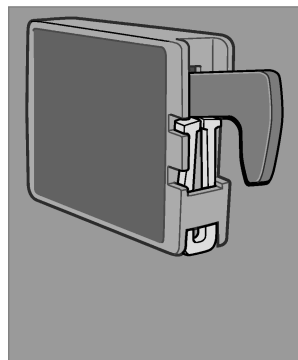
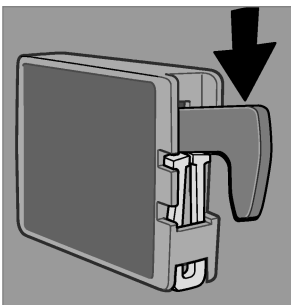

Fig. 21

Fig. 22



Releasing

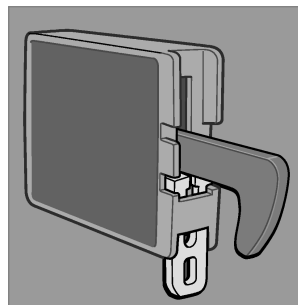

Fig. 23

Fig. 24

4.11 Lighting

The interior lighting is controlled using a door contact. Should the door be kept open for more than 2 minutes, an acoustic signal is initiated (pulsing whistle tone).

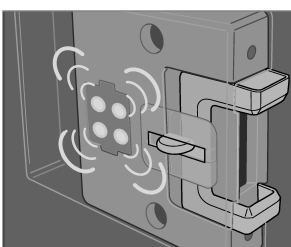

Fig. 25



In the case of a fault, contact an authorised Dometic customer service agent.

4.12 Positioning the storage racks

The storage racks may be pulled out by loosening the two locking devices (1) underneath. For loosening pull the slider to the middle, for fastening pull them sideways.

Two of the storage racks are secured. In this way inadvertent entrapment and suffocation of children is prevented, if the storage racks are removed. To protect children it must be avoided to create space for children in the cooling compartment.



WARNING!

Do not remove these storage racks. Thus children have no space to be entrapped in the refrigerator.

If it is necessary to remove these storage racks (i.e. for cleaning) loosen the locking pins (2) at first as shown, by means of a suitable screw driver.

Put in place the locking pins after removing the storage racks.

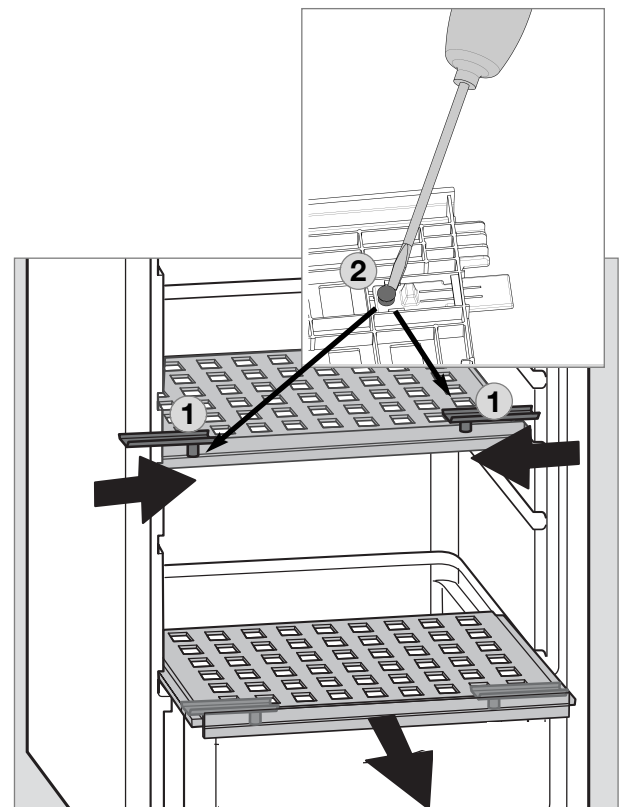

Fig. 26

4.13 Storing food and making ice cubes

4.13.1 Storing products in the cooling compartment

- Switch the refrigerator on approx. 12 hours before filling it.
- Always store pre-cooled foods in the refrigerator. Make sure that the food is well cooled when it is bought and also when transporting it. Use insulated cooling bags.
- Open the refrigerator door only for a short period of time when removing products.
- Products must be packed - best of all in closed containers, wrapped in aluminium foil or similar - and stored separately from each other, in order to prevent drying out or odours.
- Allow foods that have been warmed up to cool down before storing.
- Avoid storing products in the refrigerator that could emit volatile flammable gases.
- Do not overfill the storage grids and compartments to prevent obstructing the internal air circulation.
- Maintain a clearance of approx. 10 mm between chilled products and post-evaporator ("cooling fins").
- Do not expose the refrigerator to direct sunlight. Please bear in mind that the temperature inside a closed vehicle increases sharply if exposed to sunlight and that this can reduce the efficiency of the refrigerator.
- Ensure that air circulation of the cooling unit is not obstructed. Keep the ventilation grilles free from obstructions.

4.13.2 Storing products in the freezer compartment

- Do not keep carbonated drinks in the freezer.
- The freezer compartment is suitable for making ice cubes and for short-term storage of frozen food. It is not suitable as a means of deep freezing foods.

When ambient temperatures are lower than +10°C and the refrigerator is exposed to these temperatures for extended periods of time, an even regulation of freezer temperature cannot be guaranteed for system-related reasons. This can cause the temperature in the freezer to rise and the stored goods to melt.

4.13.3 Refrigerator compartments

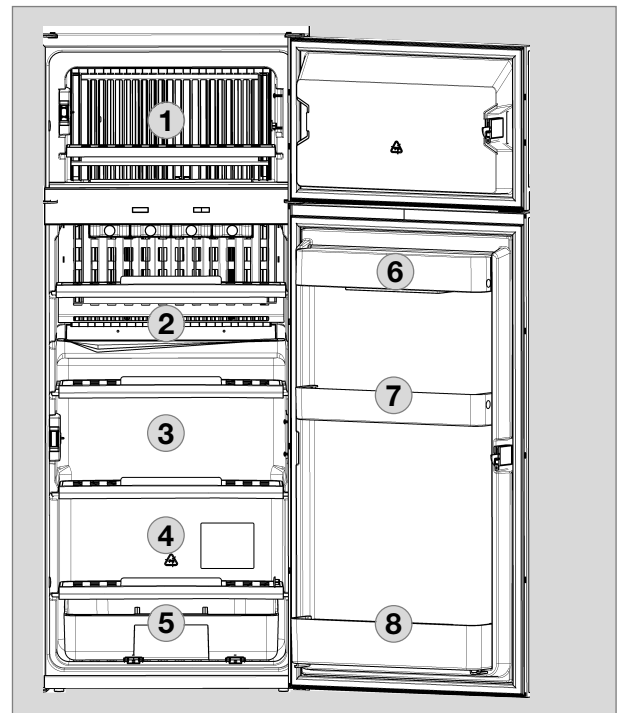

Fig. 27

- 1 **Freezer compartment :**
already frozen food (deep-frozen food)
- 2 **Top compartment:**
convenience food
- 3 **Middle compartment:**
Dairy products, convenience food
- 4 **Bottom compartment:**
Meat, fish, food for defrosting
- 5 **Vegetable compartment:**
Salads, vegetables, fruit
- 6 **Top door shelf:**
Eggs, butter
- 7 **Middle door shelf:**
Cans, dressings, ketchup, jam
- 8 **Bottom door shelf (drinks compartment):**
Drinks in bottles or bags

4.13.4 Making ice cubes

Ice cubes are best frozen overnight. At night, the refrigerator has less work to do and the unit has more reserves.



Fig. 28

1. Fill the ice cube tray with drinking water.

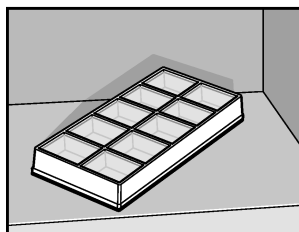

Fig. 29

2. Place the ice cube tray in the freezer compartment.



WARNING!

Only use drinking water!!

4.14 Shutting off the refrigerator

- Switch off the refrigerator by pressing button **(1)** (s. 4.5). Keep button **(1)** pressed for 3 seconds. The display disappears and the appliance is fully switched off.
- Release the locking mechanism (Fig. 30-31) of the door lock by pushing it and shift it to the front. If the door is shut in this position, a small gap is nevertheless kept open to prevent formation of mildew.

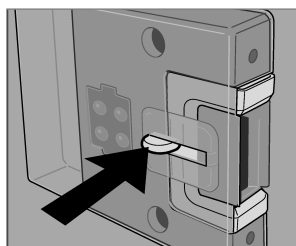

Fig. 30

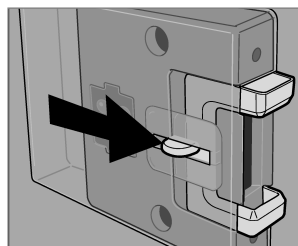

Fig. 31

- If the refrigerator is to be taken out of service for an extended period of time, close the onboard shut-off valve and the cylinder valve.

4.15 Defrosting

As time goes by, frost builds up on the fins inside the refrigerator. A layer of frost thicker on one side may occur and does not represent a malfunction. When this layer of frost is about 3 mm thick, the refrigerator should be defrosted.

- Switch off the refrigerator, as described in section *Shutting of the refrigerator*.
- Remove all food and the ice cube tray.
- Leave the refrigerator door open to allow air to enter and to prevent formation of mildew.
- After defrosting (freezer compartment and fins free of frost), wipe both cooling compartments dry with a cloth.

Note: Water thawing in the main compartment of the refrigerator runs into an appropriate container at the back of the refrigerator. From there, the water evaporates.

CAUTION!

The layer of ice must never be removed forcibly, nor may defrosting be accelerated using a heat source!

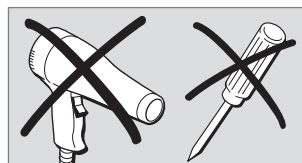

Fig. 32

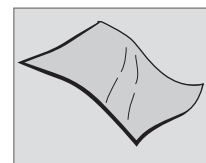

Fig. 33

4.16 Changing the decor panel

Decor panel with frame

- Remove the lateral ledge (1) the door (ledge is attached, not screwed).
- Shift decor panel (2) away from the door and insert the new decor panel. Re-attach ledge (1).

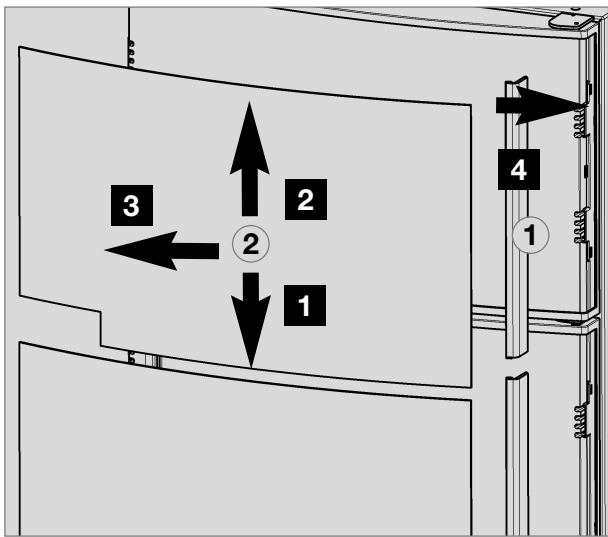

Fig. 34

CAUTION!

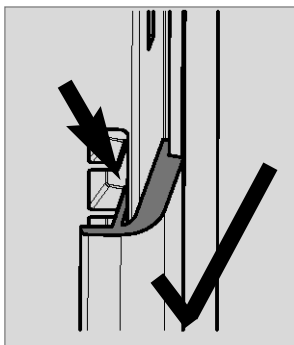

Fig. 35

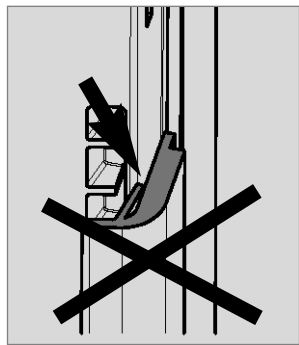

Fig. 36

Decor panel dimensions (with frame) :

Upper door

Height	Width	Thickness
300 +/- 1 mm	507,5 +/- 1 mm	max. 1.7 mm

Lower door

Height	Width	Thickness
907,4 +/- 1 mm	507,5 +/- 1 mm	max. 1.7 mm

Frameless decor panel

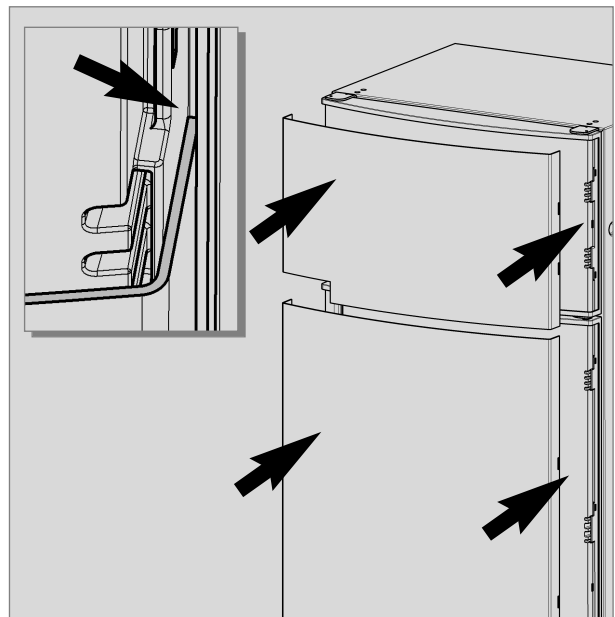

Fig. 37

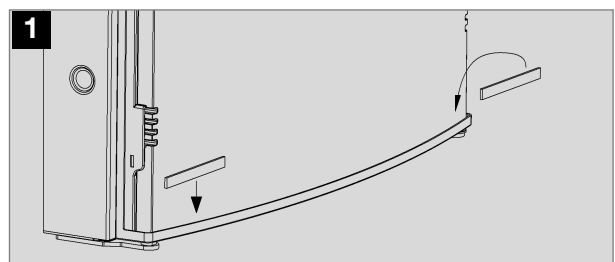

Fig. 38

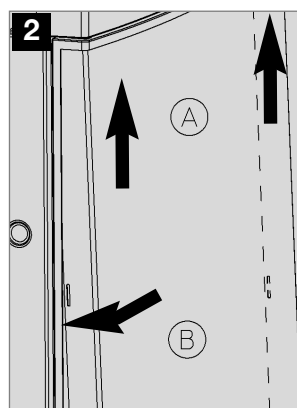

Fig. 39

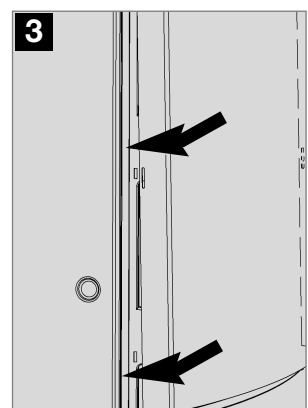

Fig. 40

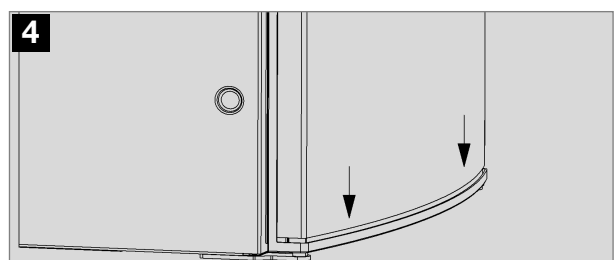

Fig. 41

4.17 Trouble-shooting

Failure: The refrigerator does not cool sufficiently.

Possible cause	Action you can take
<ul style="list-style-type: none"> - Inadequate ventilation to the unit. - Thermostat setting is too low. - The condenser is heavily frosted. - Too much warm food has been stored inside within short period of time. - The appliance has been running for only a short period of time. - Ambient temperatures too high. 	<ul style="list-style-type: none"> - Check that ventilation grilles are not covered. - Set thermostat to a higher level. - Check that the refrigerator door closes properly. - Allow warm food to cool down before storage. - Check whether the cooling compartment works after approx. 4 - 5 hours. - Regularly remove ventilation grilles.

Failure: The refrigerator does not cool in gas operation mode.

Possible cause	Action you can take
<ul style="list-style-type: none"> - Gas cylinder empty. - Is the upstream shut-off device open ? - Air in the gas pipe ? 	<ul style="list-style-type: none"> - Change gas cylinder. - Open shut-off device. - Switch off the appliance and start again. Repeat this procedure 3 - 4 times, if necessary

Failure: The refrigerator does not cool in 12V operation.

Possible cause	Action you can take
<ul style="list-style-type: none"> - On-board fuse defective. - On-board battery discharged. - Engine not running. - Heating element defective (please also refer to failure indication). 	<ul style="list-style-type: none"> - Fit new fuse. - Check battery, charge it. - Start engine. - Please inform the Dometic Customer Service

Failure: The refrigerator does not cool in 230V operation.

Possible cause	Action you can take
<ul style="list-style-type: none"> - On-board fuse defective. - Vehicle not connected to mains supply voltage. - AES: Gas operation despite connection to the mains supply voltage? - Heating element defective (please also refer to failure indication). 	<ul style="list-style-type: none"> - Fit new fuse. - Make a connection to a mains power supply. - Appliance switches to gas operation due to insufficient mains supply voltage (automatically switches back to 230V operation). - Please inform the Dometic Customer Service.

4.18 Information on failure display and trouble-shooting

- Refrigerators with an electronics system (MES, AES) indicate the occurrence of a malfunction by the LED or display flashing.
- If a malfunction occurs, the indicator LED "Failure" (8) flashes simultaneously. In the case of AES models an acoustic alarm sounds.

Before notifying the authorised Service Center, please check whether:

- the instructions in section "Operating the refrigerator" have been observed.
- the refrigerator stands level.
- it is possible to operate the refrigerator with any available power source.

4.18.1 Status indicators



MES

Fig. 42

- ① = Button ON / OFF
- ② = Energy selector switch 230 V AC
- ③ = Energy selector switch GAS
- ④ = Energy selector switch 12V DC



AES





Fig. 43

- ⑦ = temperature level display
- ⑧ = fault LED / GAS FAULT reset button

Operation with on-board 12 V power supply

Indicator	Fault	Remedy
② + ⑧ acoustic signal 20 s	230V mode: "230V" not available or voltage too low	Check mains power connection, mains voltage, fuse
④ + ⑧ acoustic signal 20 s	12V mode: "12 V" not available or voltage too low	Check 12 V connection, on-board battery, fuse AES: Check D+ signal
③ + ⑧ acoustic signal 20 s	GAS/Automatic mode: Flame not ignited	Check gas supply (gas bottle, gas valve) Press the (8) button after clearing the fault.
Acoustic signal, 15 s, at 2 minute intervals	Interior lighting is switched on	Close door, check door contact
② + ⑦ acoustic signal 20 s	230V mode: 230V heating element defective	Arrange replacement of 230V heating element, contact Customer Service
④ + ⑦ acoustic signal 20 s	12V mode: 12V heating element defective	Arrange replacement of 12V heating element, contact Customer Service
⑦ flashing	Temperature sensor without contact or defective	contact Customer Service
③ + ⑦ acoustic signal 20 s	Burner defective or cooling unit defective	Check burner, burner nozzles, if necessary contact Customer Service and arrange replacement

Operation with batteries (internal power supply)

Indicator	Fault	Remedy
③  flashing ⑧  brightly	Flame not ignited	Check gas supply (gas bottle, gas valve) Press the  (8) button after clearing the fault.
③  flashing ⑦  brightly	Burner defective or cooling unit defective	Check burner, burner nozzles, if necessary contact Customer Service and arrange replacement
Acoustic signal at 15 second intervals	Undervoltage detection (internal batteries)	Replace batteries
Automatic switching from external to internal power supply does not function (absence of the on-board 12 V power supply for the electronics)	Refrigerator does not function; gas operation not possible although the batteries are inserted.	Switch off the refrigerator and start again. The on-board power supply was interrupted during the starting of the gas operation. Note: No automatic switching is performed during the ignition.

GERMANY**Dometic WAECO International GmbH**

Hollefeldstraße 63 · D-48282 Emsdetten

☎ +49 (0) 2572 879-195 · 📠 +49 (0) 2572 879-322

Mail: info@dometic-waeco.de

dometic.com

**AUSTRALIA****Dometic Australia Pty. Ltd.**1 John Duncan Court
Varsity Lakes QLD 4227

☎ 1800 212121

☎ +61 7 55076001

Mail: sales@dometic.com.au

AUSTRIA**Dometic Austria GmbH**

Neudorferstraße 108

A-2353 Guntramsdorf

☎ +43 2236 908070

☎ +43 2236 90807060

Mail: info@dometic.at

BENELUX**Dometic Branch Office Belgium**

Zincstraat 3

B-1500 Halle

☎ +32 2 3598040

☎ +32 2 3598050

Mail: info@dometic.be

BRAZIL**Dometic DO Brasil LTDA**

Avenida Paulista 1754, conj. 111

SP 01310-920 Sao Paulo

☎ +55 11 3251 3352

☎ +55 11 3251 3362

Mail: info@dometic.com.br

DENMARK**Dometic Denmark A/S**

Nordensvej 15, Taulov

DK-7000 Fredericia

☎ +45 75585966

☎ +45 75586307

Mail: info@dometic.dk

FINLAND**Dometic Finland OY**

Mestarintie 4

FIN-01730 Vantaa

☎ +358 20 7413220

☎ +358 9 7593700

Mail: info@dometic.fi

FRANCE**Dometic SAS**

ZA du Pré de la Dame Jeanne

B.P. 5

F-60128 Plailly

☎ +33 3 44633525

☎ +33 3 44633518

Mail: vehiculesdeloisirs@dometic.fr

HONG KONG**Dometic Group Asia Pacific**

Suites 2207-11 · 22/F · Tower 1

The Gateway · 25 Canton Road,

Tsim Sha Tsui · Kowloon

☎ +852 2 4611386

☎ +852 2 4665553

Mail: info@waeco.com.hk

HUNGARY**Dometic Zrt. Sales Office**

Kerékgyártó u. 5.

H-1147 Budapest

☎ +36 1 468 4400

☎ +36 1 468 4401

Mail: budapest@dometic.hu

ITALY**Dometic Italy S.r.l.**

Via Virgilio, 3

I-47122 Forlì (FC)

☎ +39 0543 754901

☎ +39 0543 754983

Mail: vendite@dometic.it

JAPAN**Dometic KK**

Maekawa-Shibaura, Bldg. 2

2-13-9 Shibaura Minato-ku

Tokyo 108-0023

☎ +81 3 5445 3333

☎ +81 3 5445 3339

Mail: info@dometic.jp

MEXICO**Dometic Mx, S. de R. L. de C. V.**

Circuito Médicos No. 6 Local 1

Colonia Ciudad Satélite

CP 53100 Naucalpan de Juárez

Estado de México

☎ +52 55 5374 4108

☎ +52 55 5393 4683

Mail: info@dometic.com.mx

NETHERLANDS**Dometic Benelux B.V.**

Ecustraat 3

NL-4879 NP Etten-Leur

☎ +31 76 5029000

☎ +31 76 5029019

Mail: info@dometic.nl

NEW ZEALAND**Dometic New Zealand Ltd.**

PO Box 12011

Penrose

Auckland 1642

☎ +64 9 622 1490

☎ +64 9 622 1573

Mail: customerservices@dometic.co.nz

NORWAY**Dometic Norway AS**

Østerøyveien 46

N-3232 Sandefjord

☎ +47 33428450

☎ +47 33428459

Mail: firmapost@dometic.no

POLAND**Dometic Poland Sp. z o.o.**

Ul. Puławska 435A

PL-02-801 Warszawa

☎ +48 22 414 3200

☎ +48 22 414 3201

Mail: info@dometic.pl

PORTUGAL**Dometic Spain, S.L.**

Branch Office em Portugal

Rot. de São Gonçalo nº 1 – Esc. 12

2775-399 Carcavelos

☎ +351 219 244 173

☎ +351 219 243 206

Mail: info@dometic.pt

RUSSIA**Dometic RUS LLC**

Komsomolskaya square 6-1

RU-107140 Moscow

☎ +7 495 780 79 39

☎ +7 495 916 56 53

Mail: info@dometic.ru

SINGAPORE**Dometic Pte Ltd**

18 Boon Lay Way 06-140 Trade Hub 21

Singapore 609966

☎ +65 6795 3177

☎ +65 6862 6620

Mail: dometic@dometic.com.sg

SLOVAKIA**Dometic Slovakia s.r.o. Sales Office Bratislava**

Nádražná 34/A

900 28 Ivánka pri Dunaji

☎/☎ +421 2 45 529 680

Mail: bratislava@dometic.com

SOUTH AFRICA**Dometic (Pty) Ltd.****Regional Office****South Africa & Sub-Saharan Africa**

2 Avalon Road

West Lake View Ext 11

Modderfontein 1645

Johannesburg

☎ +27 11 4504978

☎ +27 11 4504976

Mail: info@dometic.co.za

SPAIN**Dometic Spain S.L.**

Avda. Sierra del Guadarrama, 16

E-28691 Villanueva de la Cañada

Madrid

☎ +34 902 111 042

☎ +34 900 100 245

Mail: info@dometic.es

SWEDEN**Dometic Scandinavia AB**

Gustaf Melins gata 7

S-42131 Västra Frölunda

☎ +46 31 7341100

☎ +46 31 7341101

Mail: info@dometicgroup.se

SWITZERLAND**Dometic Switzerland AG**

Riedackerstrasse 7a

CH-8153 Rümlang

☎ +41 44 8187171

☎ +41 44 8187191

Mail: info@dometic.ch

UNITED ARAB EMIRATES**Dometic Middle East FZCO**

P. O. Box 17860

S-D 6, Jebel Ali Freezone

Dubai

☎ +971 4 883 3858

☎ +971 4 883 3868

Mail: info@dometic.ae

UNITED KINGDOM**Dometic UK Ltd.**

Dometic House, The Brewery

Blandford St. Mary

Dorset DT11 9LS

☎ +44 344 626 0133

☎ +44 344 626 0143

Mail: customerservices@dometic.co.uk

USA**Dometic RV Division**

1120 North Main Street

Elkhart, IN 46515

☎ +1 574-264-2131