

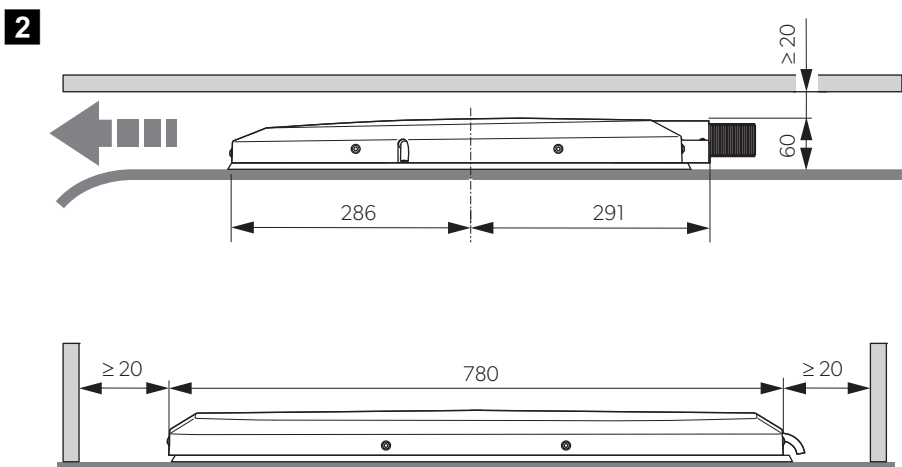

By using the product, you hereby confirm that you have read all instructions, guidelines, and warnings carefully and that you understand and agree to abide by the terms and conditions as set forth herein. Find the installation manual online on documents.dometic.com/?object_id=63124

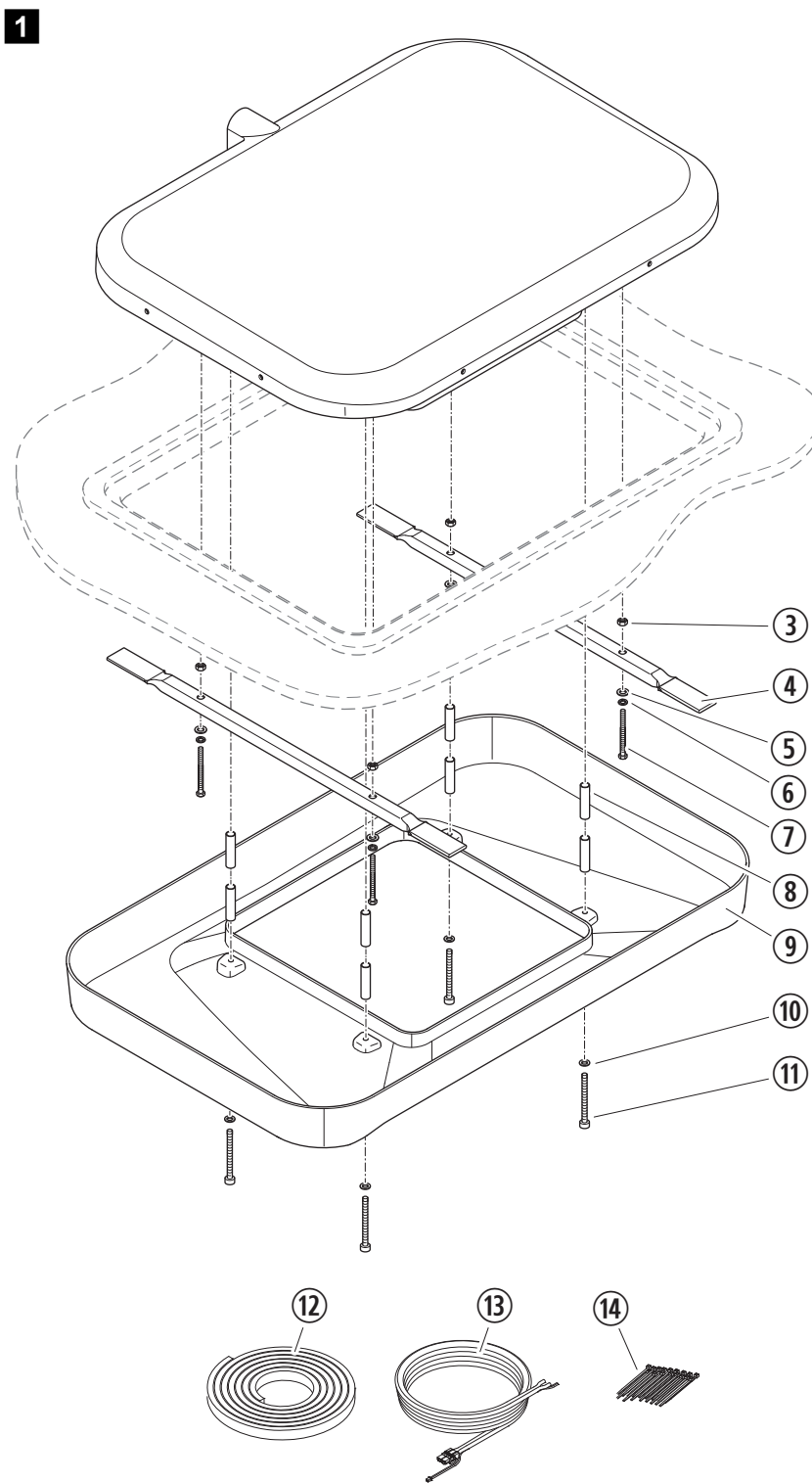

3

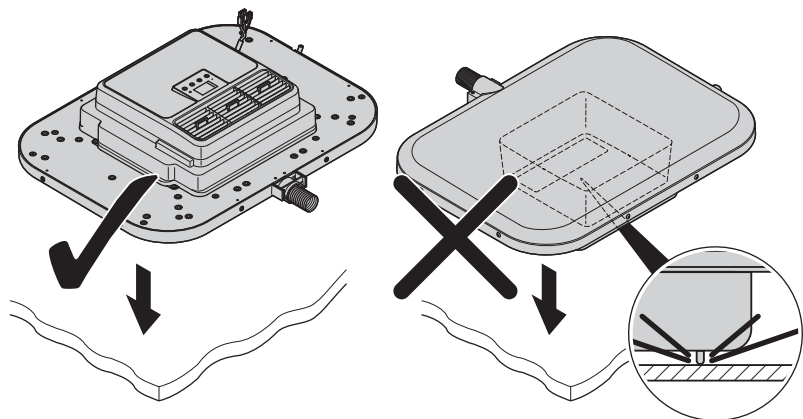
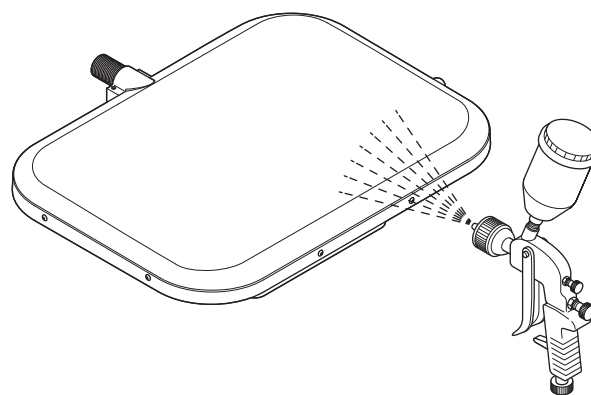

4

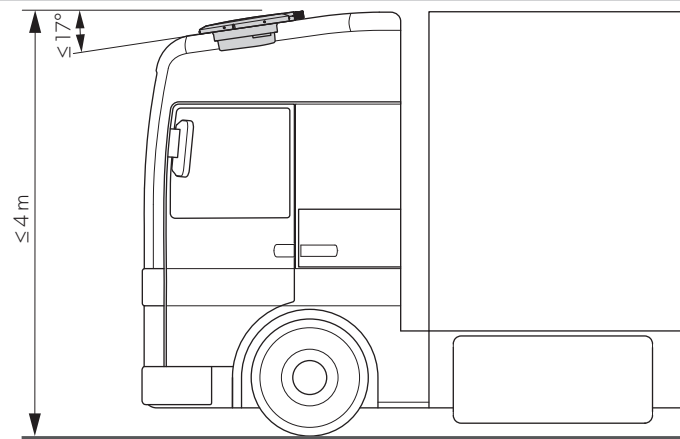

5

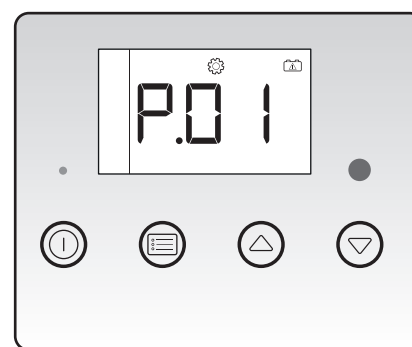

6

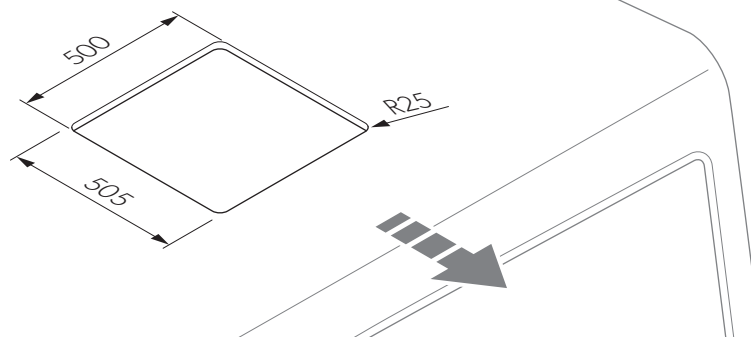

7

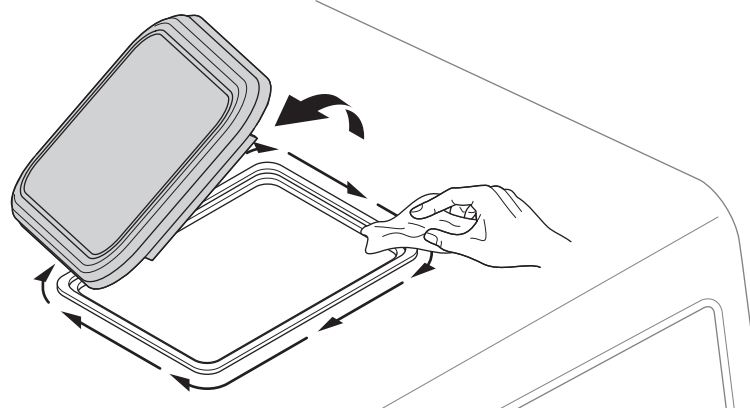

8

